



**Qualcomm® Pseudo Random Number Generator  
Version 2.1.0, 2.3.1 and 2.4.0**

**FIPS 140-2 Non-Proprietary Security Policy  
Version 1.11  
Last Update: 2023-10-27**

**Prepared for:**

**Qualcomm Technologies, Inc.  
5775 Morehouse Drive  
San Diego, CA 92121**

**Prepared by:**

**atsec information security Corp.  
9130 Jollyville Road, Suite 260  
Austin, TX 78759**

Qualcomm Pseudo Random Number Generator is a product of Qualcomm Technologies, Inc. and/or its subsidiaries.

TABLE OF CONTENTS

- 1 INTRODUCTION..... 3**
  - 1.1 PURPOSE OF THE SECURITY POLICY .....3
- 2 CRYPTOGRAPHIC MODULE SPECIFICATION..... 4**
  - 2.1 DESCRIPTION OF MODULE .....4
  - 2.2 DESCRIPTION OF APPROVED MODE .....5
  - 2.3 CRYPTOGRAPHIC MODULE BOUNDARY.....5
- 3 CRYPTOGRAPHIC MODULE PORTS AND INTERFACES ..... 13**
- 4 ROLES, SERVICES AND AUTHENTICATION ..... 14**
  - 4.1 ROLES .....14
  - 4.2 SERVICES.....14
  - 4.3 OPERATOR AUTHENTICATION.....15
  - 4.4 MECHANISM AND STRENGTH OF AUTHENTICATION .....15
- 5 PHYSICAL SECURITY..... 16**
- 6 OPERATIONAL ENVIRONMENT ..... 17**
  - 6.1 APPLICABILITY .....17
- 7 CRYPTOGRAPHIC KEY MANAGEMENT ..... 18**
  - 7.1 RANDOM NUMBER GENERATION .....18
  - 7.2 KEY AND CSP LIST .....18
  - 7.3 KEY/CSP GENERATION, ENTRY AND OUTPUT.....19
  - 7.4 KEY/CSP STORAGE AND ZEROIZATION .....19
- 8 ELECTROMAGNETIC INTERFERENCE/ELECTROMAGNETIC COMPATIBILITY (EMI/EMC) ..... 20**
- 9 POWER-UP TESTS ..... 21**
  - 9.1 CRYPTOGRAPHIC ALGORITHM TESTS.....21
  - 9.2 CONDITIONAL TESTS.....21
- 10 DESIGN ASSURANCE ..... 22**
  - 10.1 CONFIGURATION MANAGEMENT .....22
- 11 MITIGATION OF OTHER ATTACKS ..... 23**
- 12 GLOSSARY AND ABBREVIATIONS ..... 24**
- 13 REFERENCES ..... 25**

## 1 Introduction

This document is the non-proprietary FIPS 140-2 Security Policy for the Qualcomm Pseudo Random Number Generator cryptographic modules. The version numbers of the Qualcomm Pseudo Random Number Generator are 2.1.0, 2.3.1 and 2.4.0. This document contains a specification of the rules under which the Qualcomm Pseudo Random Number Generator must operate. It also describes how the Qualcomm Pseudo Random Number Generator meets the requirements as specified in FIPS PUB 140-2 (Federal Information Processing Standards Publication 140-2) for Security Level 1 hardware cryptographic modules.

### 1.1 Purpose of the Security Policy

There are three major reasons that a security policy is needed:

- It is required for FIPS 140-2 validation.
- It allows individuals and organizations to determine whether the Qualcomm Pseudo Random Number Generator, as implemented, satisfies the stated security policy.
- It describes the capabilities, protections, and access rights provided by the Qualcomm Pseudo Random Number Generator. This essential information will help individuals and organizations determine whether the Qualcomm Pseudo Random Number Generator will meet their security requirements.

## 2 Cryptographic Module Specification

### 2.1 Description of Module

The Qualcomm Pseudo Random Number Generator is classified as a single chip hardware module for the purpose of FIPS 140-2 validation. It is designed to provide random numbers. The Qualcomm Pseudo Random Number Generator is a sub-chip hardware component contained within the Snapdragon<sup>®1</sup> 820 SoC, Snapdragon 845 SoC, Snapdragon 855 SoC, Snapdragon 865 Mobile Platform SoC, Snapdragon 888 5G Mobile Platform SoC, Snapdragon 8cx Gen 3 Mobile Compute Platform SoC, and Snapdragon 695 5G Mobile Platform SoC. The Qualcomm Pseudo Random Number Generator implements a SHA-256 Hash DRBG as defined in SP 800-90A.

The hardware sub-chip cryptographic modules are specified in the following table:

Component	Type	Version Number
Qualcomm Pseudo Random Number Generator	hardware	2.1.0
Qualcomm Pseudo Random Number Generator	hardware	2.3.1
Qualcomm Pseudo Random Number Generator	hardware	2.4.0

*Table 1: Components of the Hardware Cryptographic Module*

The Qualcomm Pseudo Random Number Generator has been tested on the following platforms:

Snapdragon 820 for version 2.1.0, Snapdragon 845, Snapdragon 855, Snapdragon 865 Mobile Platform for version 2.3.1, and the Snapdragon 888 5G Mobile Platform, and Snapdragon 8cx Gen 3 Mobile Compute Platform, and Snapdragon 695 5G Mobile Platform for version 2.4.0

The Qualcomm Pseudo Random Number Generator is intended to meet the requirements of FIPS 140-2 at an overall Security Level 1. The table below shows the security level claimed for each of the eleven sections that comprise the validation:

FIPS 140-2 Sections	Security Level				
	N/A	1	2	3	4
Cryptographic Module Specification		X			
Cryptographic Module Ports and Interfaces		X			
Roles, Services and Authentication		X			
Finite State Model		X			
Physical Security		X			
Operational Environment	X				

<sup>1</sup> Snapdragon is a product of Qualcomm Technologies, Inc. and/or its subsidiaries.

Cryptographic Key Management		X			
EMI/EMC		X			
Self-Tests		X			
Design Assurance		X			
Mitigation of Other Attacks	X				

Table 2: Security Levels

## 2.2 Description of Approved Mode

The Qualcomm Pseudo Random Number Generator supports only a FIPS mode which is entered without any special configurations. All possible configurations entered via the registers are supported and do not violate the constraints of the FIPS mode.

When the Qualcomm Pseudo Random Number Generator is powered on, the power-up self-test is executed automatically without any operator intervention. The Qualcomm Pseudo Random Number Generator enters FIPS mode automatically if the power-up self-test completes successfully.

If any of self-tests fail during power-up, the Qualcomm Pseudo Random Number Generator goes into Error state. All cryptographic services are prohibited while in error state. When an error state is entered, the Qualcomm Pseudo Random Number Generator can be reset to reinitialize itself.

The status of the Qualcomm Pseudo Random Number Generator can be determined by its availability. If the Qualcomm Pseudo Random Number Generator is available, it has passed all self-tests. If it is unavailable, it is in the error state.

The Qualcomm Pseudo Random Number Generator provides the following CAVP validated algorithms (Note that the Qualcomm Pseudo Random Number Generator has two cores each implementing SHA-256) and the allowed algorithm:

Algorithms	Standards	CAVP Certs #		
		version 2.1.0	version 2.3.1	Version 2.4.0
SHA-256 Hash DRBG	SP-800-90A	Cert.#: 885	Certs. #1788, #C443 and #A50	Certs. #A764 and #A1630
SHA-256 (core 1)	FIPS 180-4	Cert.#: 2908	Certs. #4047, #C443 and #A50	Certs. #A764 and #A1630
SHA-256 (core 2)	FIPS 180-4	Cert.#: 2930	Certs. #4048, #C441 and #A49	Certs. #A763 and #A1631
NDRNG used to seed DRBG	N/A	N/A (Allowed)	N/A (Allowed)	N/A (Allowed)

Table 3: Approved and Allowed Algorithms

## 2.3 Cryptographic Module Boundary

The physical boundary of the Qualcomm Pseudo Random Number Generator is the physical boundary of the Snapdragon 820 SoC, Snapdragon 845 SoC, Snapdragon 855 SoC, Snapdragon 865 Mobile Platform SoC, Snapdragon 888 5G Mobile Platform, Snapdragon 8cx Gen 3 Mobile Compute Platform, and Snapdragon 695 5G Mobile Platform SoC, that contains the sub-chip which implements the Qualcomm Pseudo Random Number Generator version 2.1.0, 2.3.1 and 2.4.0 respectively. Consequently, the embodiment of the Qualcomm Pseudo Random Number Generator is a single-chip standalone cryptographic module. The logical boundary is the Qualcomm Pseudo Random Number Generator, versions 2.1.0, 2.3.1 and 2.4.0.

The following figure illustrates the various data, status and control paths through the physical and logical boundary of the Qualcomm Pseudo Random Number Generator.

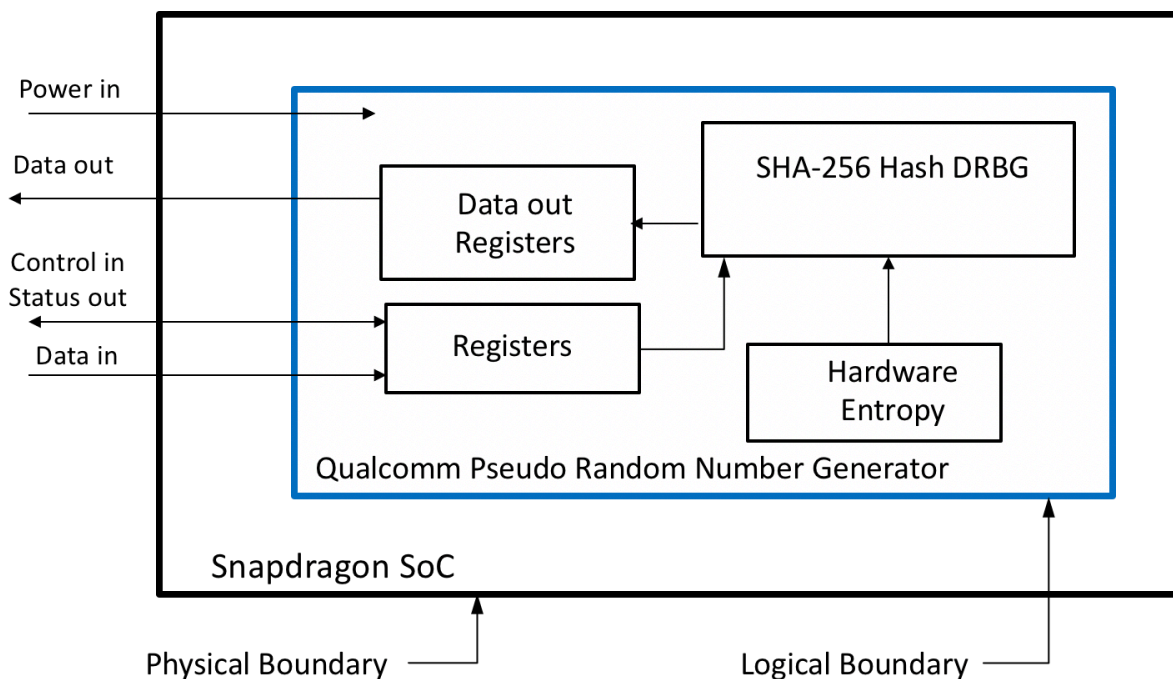
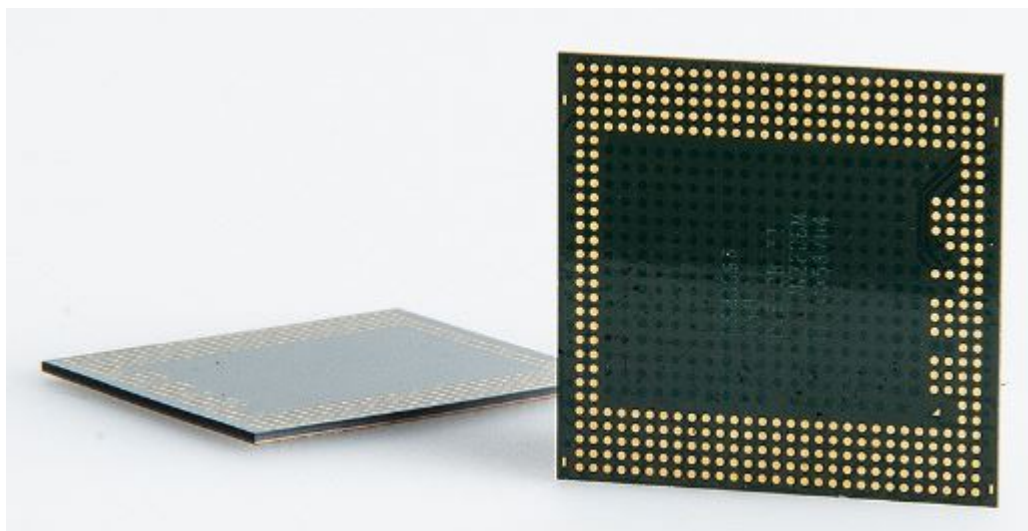
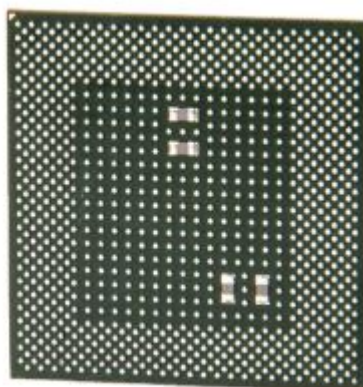

Figure 1: Cryptographic Boundary



Back view



Front view

*Figure 2: Snapdragon 820*

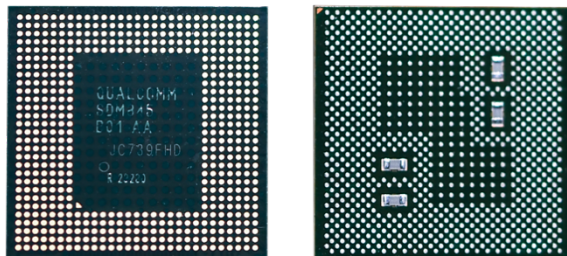

Figure 3: Snapdragon 845



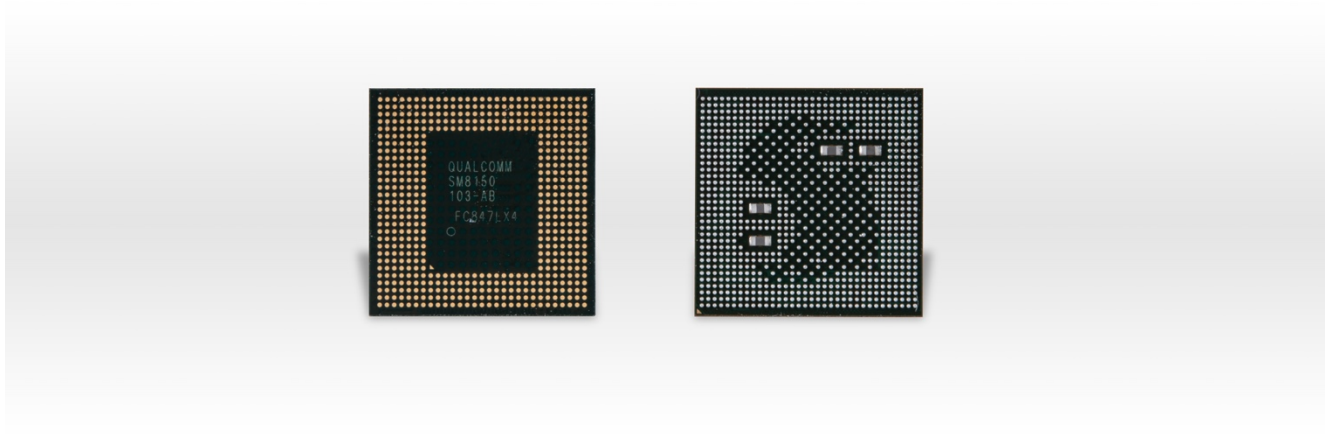

Figure 4: Snapdragon 855

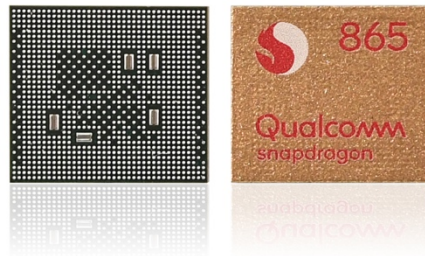

Figure 5: Snapdragon 865 Mobile Platform

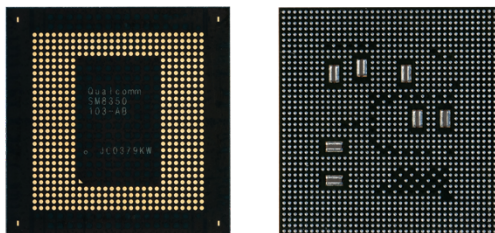

Figure 6: Snapdragon 888 5G Mobile Platform

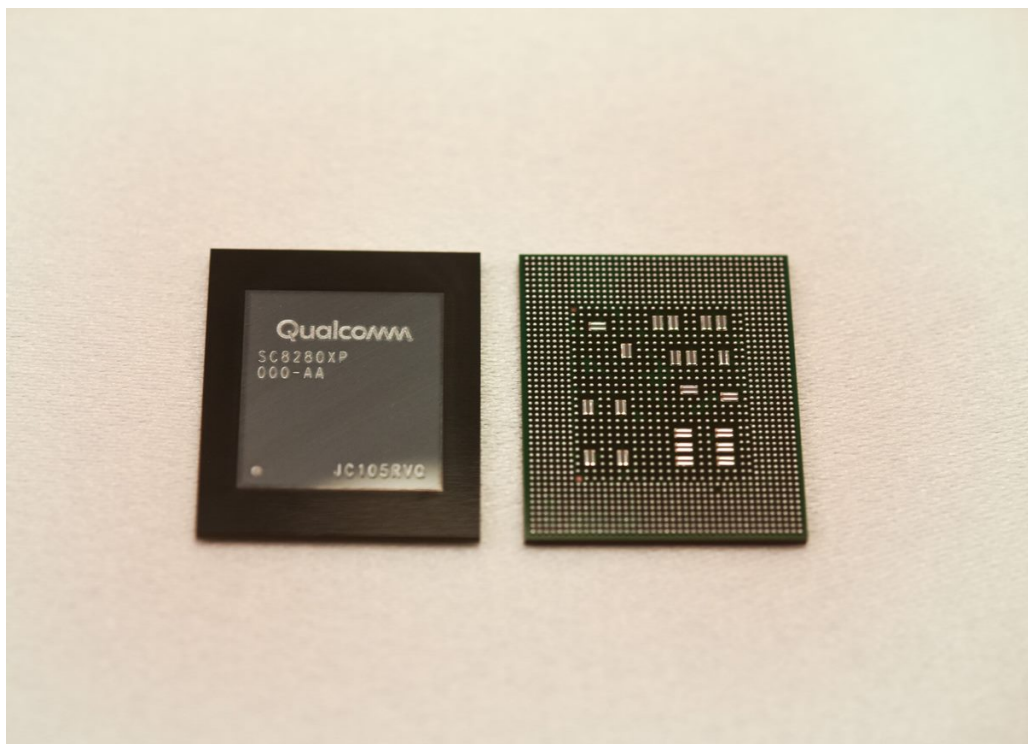

Figure 7: Snapdragon 8cx Gen 3 Mobile Compute Platform

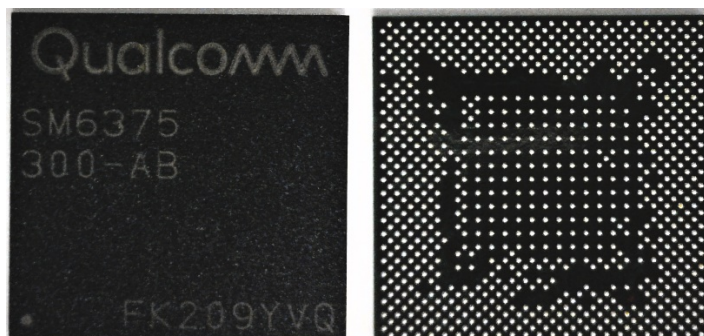

Figure 8: Snapdragon 695 5G Mobile Platform

## Cryptographic Module Ports and Interfaces

FIPS Interface	Ports
Data Input	Registers
Data Output	Data Out Registers
Control Input	Registers
Status Output	Registers
Power Input	Physical power connector

*Table 4: Ports and Interfaces*

As indicated in Table 4, all status output and control input are directed through the interface of the Qualcomm Pseudo Random Number Generator’s logical boundary, which is the registers of the Qualcomm Pseudo Random Number Generator. For data input, the registers provide the interface. For data output, the data output is provided via data out registers.

## 4 Roles, Services and Authentication

### 4.1 Roles

Role	Description
User	Perform general security services, including cryptographic operations and other approved security functions.
Crypto Officer (CO)	Configuration of the Qualcomm Pseudo Random Number Generator.

Table 5: Roles

The Qualcomm Pseudo Random Number Generator meet all FIPS 140-2 Security Level 1 requirements for Roles and Services, implementing both User and Crypto Officer roles. It does not allow concurrent operators.

The User and Crypto Officer roles are implicitly assumed by the entity accessing services implemented by the Qualcomm Pseudo Random Number Generator. No further authentication is required. The Crypto Officer can initialize the Qualcomm Pseudo Random Number Generator.

### 4.2 Services

The Qualcomm Pseudo Random Number Generator does not support bypass capability. It provides random data from the SHA-256 Hash DRBG. The following table describes the services available in FIPS-mode:

Service	Roles		CSP	Access (Read, Write)
	User	CO		
<b>Approved</b>				
SHA-256-Hash-DRBG	✓		Seed, entropy input string, nonce, internal state values C and V	R,W
Self-Test (Self-Test is executed automatically when device is booted or restarted)	✓		N/A	N/A
Check Status/Get State	✓		N/A	N/A
Module Configuration		✓	N/A	N/A
Zeroization	✓		Seed, entropy input string, nonce, internal state values C and V	R,W
<b>Non-approved but Allowed</b>				
NDRNG	✓		Entropy input string, nonce	R

Table 6: Services

### 4.3 Operator Authentication

There is no operator authentication; assumption of role is implicit by action.

### 4.4 Mechanism and Strength of Authentication

No authentication is required at Security Level 1; authentication is implicit by assumption of the role.

## 5 Physical Security

The Qualcomm Pseudo Random Number Generator with version 2.1.0 and 2.3.1 are sub-chip modules implemented as part of the Snapdragon 820 SoC, Snapdragon 845 SoC, Snapdragon 855 SoC, Snapdragon 865 Mobile Platform SoC and with version 2.4.0 implemented as part of the Snapdragon 888 5G Mobile Platform SoC, Snapdragon 8cx Gen 3 Mobile Compute Platform SoC, and Snapdragon 695 5G Mobile Platform SoC, which are the physical boundaries of the sub-chip modules. The Snapdragon 820 SoC, Snapdragon 845 SoC, Snapdragon 855 SoC, Snapdragon 865 Mobile Platform SoC, Snapdragon 888 5G Mobile Platform SoC, Snapdragon 8cx Gen 3 Mobile Compute Platform SoC, and Snapdragon 695 5G Mobile Platform SoC are single chips with a production grade enclosure and hence conform to the Level 1 requirements for physical security.



## **6 Operational Environment**

### **6.1 Applicability**

The Qualcomm Pseudo Random Number Generator is a single chip hardware module. The procurement, build and configuring procedure are controlled. Therefore, the operational environment is considered non-modifiable.

Minimum, nominal, and maximum voltages and temperatures are 0.815v, 0.90v, and 1.05v and -30C, 25C, and 85C respectively. However, each target varies slightly in voltage and temperature spec. This is a digital oscillator and will work for the voltage and temperature conditions above. The dynamic check is done by health monitor as per FIPS140-2 requirements.

## 7 Cryptographic Key Management

### 7.1 Random Number Generation

Hardware is used to collect random bits as the entropy seed (i.e., the entropy input string and the nonce) for the Qualcomm Pseudo Random Number Generator to generate FIPS 140-2 compliant random numbers.

The DRBG used to generate pseudo random numbers is a SP 800-90A compliant SHA-256 Hash DRBG using a derivation function without prediction resistance. It processes a personalization string that is written by the calling application into a hardware register for use by the Qualcomm Pseudo Random Number Generator. The calling application has read/write access to the hardware register that holds the personalization string.

The implementation performs a continuous self-test, a health check, and a power-on self-test. A re-seed process is applied to the DRBG. The re-seed frequency is programmable, up to  $2^{32}$  blocks of data.

When the DRBG is instantiated, it runs a self-test with a set of test vectors. It also runs a health check test to verify that the instantiation function and generation function are able to handle any incorrect parameter inputs, such as, a negative number for the input data length, etc. The DRBG implements a continuous self-test that verifies the random number generation. The self-test compares the output bits with the generated bits from the previous round and ensures that they do not match.

The entropy source for the DRBG originates from a series of ring oscillators. The NDRNG consists of the combined data streams of the oscillators which is fed into the DRBG. The DRBG also implements a derivation function to counter any slight imperfections in the entropy stream. Based on an analysis of the entropy output and the use of a 256-bit entropy value along with a 128-bit nonce, it has been determined that the input random data into the approved HASH DRBG contains at least 256 bits of security strength. Please note that the nonce is generated from the same entropy source there by forming a “extra strong” entropy input in accordance with section 8.6.7 of SP 800-90A.

The output of the noise source is processed by a continuous self-test which compares the output bits with the generated bits from the previous round and ensures that they do not match.

### 7.2 Key and CSP List

The entropy input string and the nonce inputs to the DRBG are generated internal to the hardware Qualcomm Pseudo Random Number Generator and do not have an external interface.

The following table lists the CSP in the Qualcomm Pseudo Random Number Generator:

CSP	Generation	Storage	Zeroization
DRBG Seed, entropy input string and nonce	Hardware NDRNG	Internal registers	Reset event

DRBG (internal state values C and V)	Hardware NDRNG	Internal registers	Reset event
--------------------------------------	----------------	--------------------	-------------

*Table 7: Keys and CSPs*

### 7.3 Key/CSP Generation, Entry and Output

The Qualcomm Pseudo Random Number Generator does not provide any key generation service or perform key generation for any of its Approved algorithms. The caller of the DRBG can use the output for key generation.

The Qualcomm Pseudo Random Number Generator does not provide any asymmetrical algorithms or key establishment methods.

### 7.4 Key/CSP Storage and Zeroization

The entropy input string and nonce used by the DRBG are generated internally by the hardware and are not accessible externally to the Qualcomm Pseudo Random Number Generator. The personalization string is input by the caller of the DRBG into a register that is able to be read from and written to by the caller.

Zeroization of the DRBG CSPs is accomplished by either a reset event or a power-off/power-on cycle of the DRBG.

## **8 Electromagnetic Interference/Electromagnetic Compatibility (EMI/EMC)**

The CM hardware component cannot be certified by the FCC as it is not a standalone device. It is a sub-chip imbedded in the Snapdragon 820 SoC, Snapdragon 845 SoC, Snapdragon 855 SoC, Snapdragon 865 Mobile Platform SoC, Snapdragon 888 5G Mobile Platform SoC, Snapdragon 8cx Gen 3 Mobile Compute Platform SoC, and Snapdragon 695 5G Mobile Platform SoC , which are also not standalone devices. It is intended to be used within a COTS device which would undergo standard FCC certification for EMI/EMC.

According to 47 Code of Federal Regulations, Part 15, Subpart B, Unintentional Radiators, the CM is not subject to EMI/EMC regulations because it is a subassembly that is sold to an equipment manufacturer for further fabrication. That manufacturer is responsible for obtaining the necessary authorization for the equipment with the CM embedded prior to further marketing to a vendor or user.

## 9 Power-Up Tests

Power-Up tests consist of Known-Answer-Tests (KAT) used for algorithm implementations. The power-up self-tests are automatically performed without any operator intervention during power-up of the Qualcomm Pseudo Random Number Generator. If any of the power-up self-tests fail, the Qualcomm Pseudo Random Number Generator will enter the error state. Data output is prohibited, and no further cryptographic operation is allowed while in the error state. The Qualcomm Pseudo Random Number Generator can be reset to recover from the error state. Re-initialization is also possible by doing a power-cycle to set the Qualcomm Pseudo Random Number Generator to the power-on state.

FIPS 140-2 explicitly allows that the on-demand test can be fulfilled with a power cycle of the Qualcomm Pseudo Random Number Generator. Hence, a power cycle and its associated power-on self-test is the methodology used to perform the "on-demand" tests.

### 9.1 Cryptographic Algorithm Tests

Algorithm	Test
SP 800-90A DRBG	KAT for DRBG only
SHA-256	KAT performed for both SHA-256 cores independently

*Table 8: Power-Up Cryptographic Algorithm Tests*

### 9.2 Conditional Tests

The following table provides the lists of the conditional self- tests. If any of the conditional test fails, the Qualcomm Pseudo Random Number Generator will enter the error state. The Qualcomm Pseudo Random Number Generator needs to be reset in order to recover from the error state.

Algorithm	Test
SP 800-90A DRBG	Continuous Random Number Generator Test
Hardware NDRNG	Continuous Random Number Generator Test

*Table 9: Conditional Tests*

## **10 Design Assurance**

The Qualcomm Pseudo Random Number Generator is implemented in hardware and is not modifiable; therefore, no integrity test is required.

### **10.1 Configuration Management**

ClearCase, a version control system from IBM/Rational, is used to manage the revision control of the hardware code (Verilog code) and hardware documentation. The ClearCase version control system provides version control, workspace management, parallel development support, and build auditing. The Verilog code is maintained within the ClearCase database used by Qualcomm Technologies, Inc.

## **11 Mitigation of Other Attacks**

No other attacks are mitigated.

## 12 Glossary and Abbreviations

<b>CAVP</b>	Cryptographic Algorithm Validation Program
<b>CMVP</b>	Cryptographic Module Validation Program
<b>COTS</b>	Commercial Off The Shelf
<b>CSP</b>	Critical Security Parameter
<b>DRBG</b>	Deterministic Random Bit Generator
<b>FIPS</b>	Federal Information Processing Standards Publication
<b>KAT</b>	Known Answer Test
<b>NIST</b>	National Institute of Science and Technology
<b>SHA</b>	Secure Hash Algorithm
<b>SoC</b>	System on Chip



## 13 References

- [1] FIPS 140-2 Standard,  
<http://csrc.nist.gov/groups/STM/cmvp/standards.html>
- [2] FIPS 140-2 Implementation Guidance,  
<http://csrc.nist.gov/groups/STM/cmvp/standards.html>
- [3] FIPS 180-4 Secure Hash Standard,  
<http://csrc.nist.gov/publications/PubsFIPS.html>
- [4] NIST Special Publication 800-90A, Recommendation for Random Number Generation Using  
Deterministic Random Bit Generators  
<https://csrc.nist.gov/publications/detail/sp/800-90a/rev-1/final>